

Technical  
Reference

# Smooth Silent Ecological

## Special Environmental Specifications of THK Linear Motion Systems



For details, visit THK at [www.thk.com](http://www.thk.com)

\*Product information is updated regularly on the THK website.

# Special Environmental Specifications of

## **THK** Linear Motion Systems

The linear motion systems used in special environments such as semiconductor production systems, liquid crystal production systems, health care equipment and food processing machinery are the product of roughly 30 years of technology and a vast amount of experience.

This brochure provides an introduction to the special environmental specifications products created by taking full advantage of **THK**'s proprietary Caged Ball Technology, materials technology, lubrication technology and surface treatment technology in order to effectively respond to the increasingly diversified needs of today.

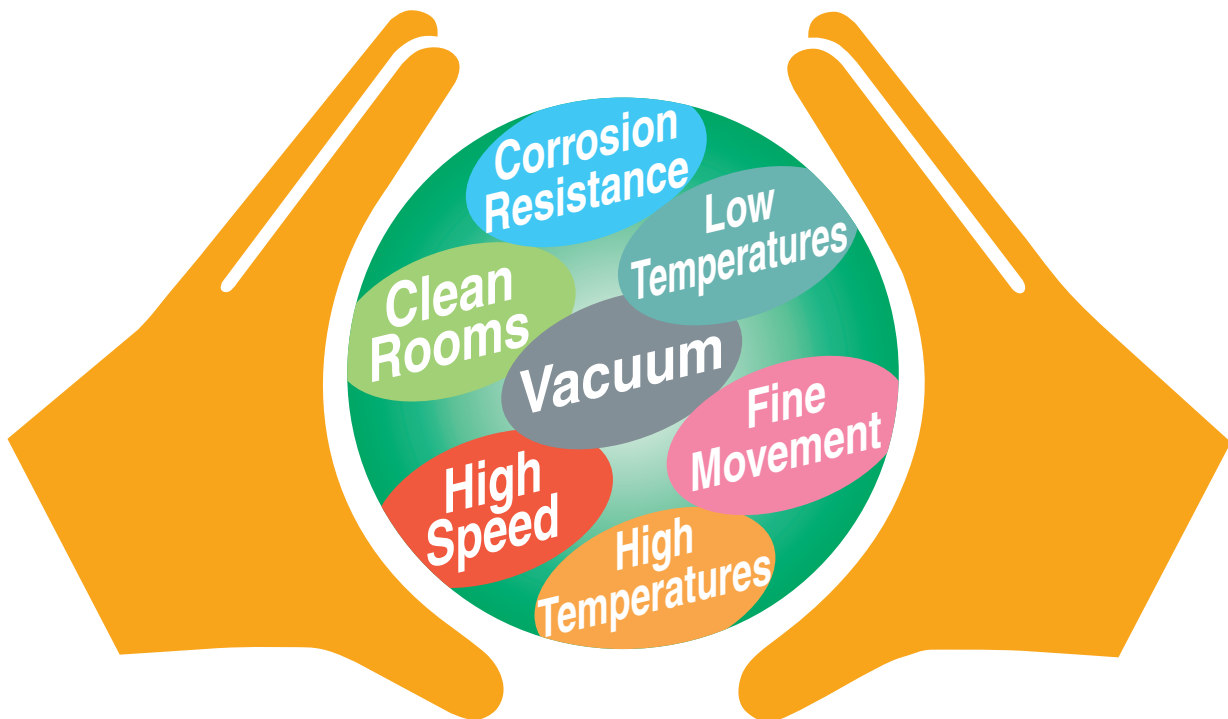

# 1 Clean Rooms

In clean environments such as the environments found in clean rooms, it is necessary to reduce the generation of dust by linear motion systems as well as enhance rust preventive performance since rust preventive films cannot be used. In addition, depending on the degree of cleanliness of the clean room, it is also necessary to use a dust collector.

## Generation of Dust from Linear Motion Systems

### Measures against dust generation caused by splattering of grease:

#### **THK AFE-CA Grease and AFF Grease**

Grease resulting in low generation of dust is used and is suitable for clean environments.

### Measures against dust generation caused by production of metal wear fragments:

#### **LM Guide with Ball Cage**

The use of the LM Guide with Ball Cage reduces the level of metal wear fragments produced by eliminating friction between the balls, thereby making it possible to suppress the generation of dust.

## Rust Prevention

### Material countermeasures:

#### **Stainless Steel LM Guide**

This LM Guide uses martensite stainless steel that is effective in prohibiting rust.

#### **High Corrosion Resistance LM Guide**

The LM Rail uses austenite stainless steel resulting in a high degree of rust preventive effects.

### Surface treatment countermeasures:

#### **THK AP-C Treatment, AP-CF Treatment and AP-HC Treatment**

Surface treatment (plating) of linear motion systems results in improved rust prevention capabilities.

# 2 Vacuum

In vacuum environments, it is necessary to select products having excellent rust prevention capabilities as countermeasures against dispersion of gases released from resins and splattering of grease since rust preventive oil cannot be used.

### Measures against gas released from resins:

#### **Stainless Steel LM Guide**

Stainless steel is used for the material of the end plates of the LM block (through which plastic balls circulate) to reduce the levels of released gas.

### Measures against grease splattering:

#### **Vacuum Grease**

When general-purpose grease is used in a vacuum environment, the oil component of the grease ends up dispersing resulting in a loss of lubricity. Consequently, vacuum grease is used that uses a fluorine-based oil having a low vapor pressure for the base oil.

### Rust preventative countermeasures:

#### **Stainless Steel LM Guide**

The stainless steel LM Guide is used in vacuum environments due to its excellent rust preventative effects.

#### **High-Temperature LM Guide**

The high-temperature LM Guide is used in cases of being subjected to high temperatures such as during baking, etc. because of its excellent heat resistance and corrosion resistance.

## 3 Corrosion Resistance

Similar to the case of use in clean rooms, corrosion resistance is enhanced by selecting appropriate materials and surface treatment.

### Material countermeasures:

#### Stainless Steel LM Guide

This LM Guide uses martensite stainless steel that is effective in prohibiting rust.

#### High Corrosion Resistance LM Guide

The LM Rail uses austenite stainless steel resulting in a high degree of rust preventative effects.

### Surface treatment countermeasures:

**THK AP-C Treatment, AP-CF Treatment and AP-HC Treatment**  
Surface treatment (plating) of linear motion systems results in improved rust prevention capabilities.

## 4 High Speed

In high-speed environments, an optimum lubrication method is required that suppresses the generation of heat during high-speed motion and improves the retention capabilities of the grease.

### Measures against heat generation:

#### LM Guide with Ball Cage

Heat generation is reduced as a result of the ball cage eliminating friction between the balls. Moreover, since the retention capabilities of the grease are improved, a long service life and outstanding high-speed performance are achieved.

#### High-Speed Ball Screw with Ball Cage (DN value up to 160,000)

The use of a ball cage realizes the ideal ball circulation structure, enabling high-speed feeding unable to be realized with conventional products.

#### THK AFG Grease

The use of grease capable of suppressing heat generation during high-speed use while also offering excellent lubricity makes it possible to achieve high-speed feeding.

### Lubrication countermeasures:

#### Lubricator QZ

Lubricator QZ makes it possible to significantly extend lubrication maintenance intervals by compensating for lost oil. Since only the minimal amount of lubricating oil is applied to the rolling surface, the surroundings are not soiled resulting in a lubrication system that is environmentally friendly.

## Special Environmental Specifications of **THK** Linear Motion Systems

### 5 High Temperatures

In high-temperature environments, the effects of dimensional changes caused by heat can become a problem. The High-Temperature LM Guide and High-Temperature Grease are used because they offer outstanding heat resistance and are subjected to minimal dimensional changes following heating and cooling.

#### Heat resistance:

#### High-Temperature LM Guide

This LM Guide offers outstanding heat resistance and is subjected to only minimal dimensional changes following heating and cooling.

#### Grease:

#### High-Temperature Grease

High-temperature grease is used because it causes only minor fluctuations in rolling resistance even during temperature changes from normal temperature to high temperatures.

### 6 Low Temperatures

Under low-temperature conditions, grease is used that results in minimal effects on plastic parts caused by low temperatures while also minimizing fluctuations in rust preventative countermeasures caused by temperature changes from normal to low temperatures as well as fluctuations in rolling resistance even at low temperatures.

#### Effects of low temperatures on plastic parts:

#### Stainless Steel LM Guide

Stainless steel is used for the material of the end plates of the LM block (through which plastic balls circulate).

#### Rust preventative countermeasures:

Surface treatment of the linear motion system results in enhanced rust preventative capabilities.

#### Grease:

**THK** AFC Grease is used that exhibits only minor fluctuations in rolling resistance even at low temperatures.

### 7 Fine movement

Extremely short strokes can cause oil films to be depleted and ineffective lubrication eventually leading to rapid wear. In cases such as this, a grease is selected that has excellent oil film strength and enables the oil film to be formed easily.

#### Grease:

#### THK AFC Grease

This urea-based grease offers excellent oil film strength and wear resistance.

# Special Environmental Specifications of Linear Motion Systems

## Clean Rooms

- Measures against dust generation
- Rust preventative countermeasures

### LM Guide with Caged Ball Technology

Applicable types

**SHS**    **SNR/SNS**  
**SSR**    **SHW**    **SRS**

### Stainless Steel LM Guide

Applicable types

**HSR**    **SR**    **SSR**  
**HR**    **RSR**    **SHW**  
**HRW**    **RSH**    **SRS**

### High Corrosion Resistance LM Guide

Applicable type

**HSR-M2**

### Surface Treatment

### Grease

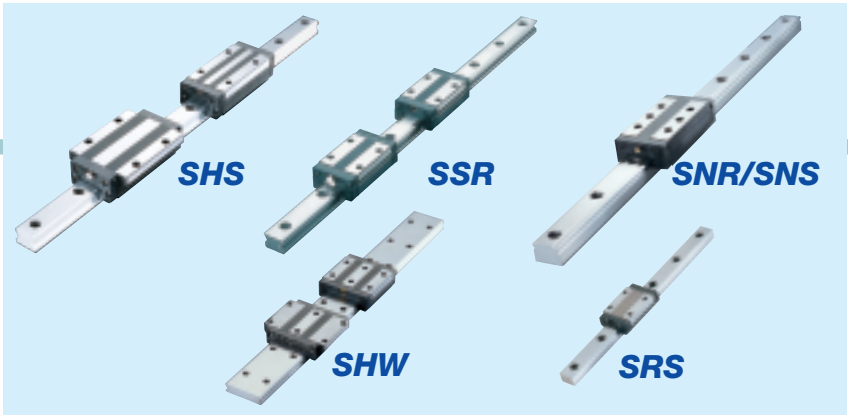

P.15~

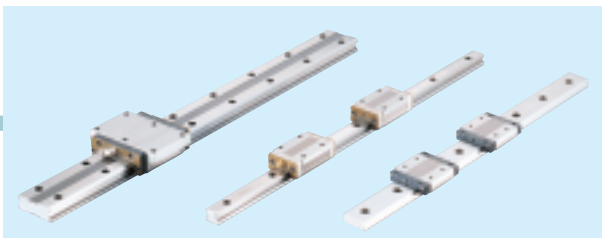

P.19~

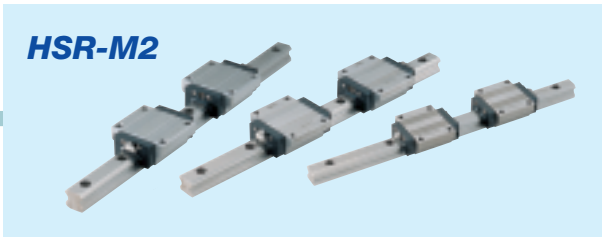

P.19~

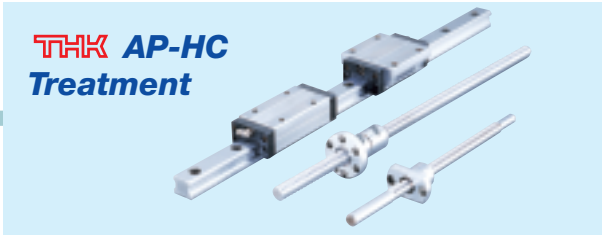

P.21~



P.23~



P.24~

# Special Environmental Specifications of Linear Motion Systems

## Vacuum

- Measures against released gases
- Measures against grease splatter
- Rust preventative countermeasures

### High-Temperature LM Guide

Applicable types **HSR-M1** **RSR-M1**  
**SR-M1**

### High Corrosion Resistance LM Guide

Applicable type **HSR-M2**

### Stainless Steel LM Guide

Applicable types **HSR** **SR** **HR**  
**RSR** **HRW** **RSH**

### Vacuum Grease

**HSR-M1**  
**SR-M1**  
**RSR-M1**

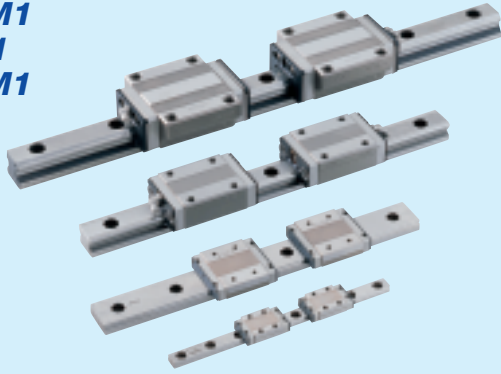

P.20~

**HSR-M2**

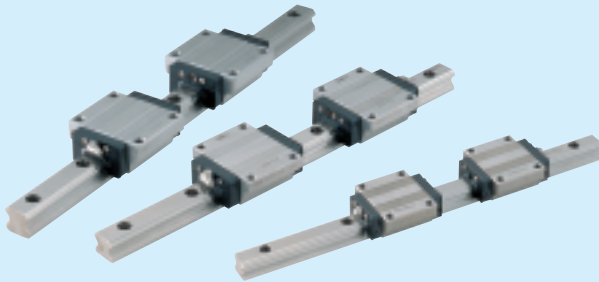

P.19~

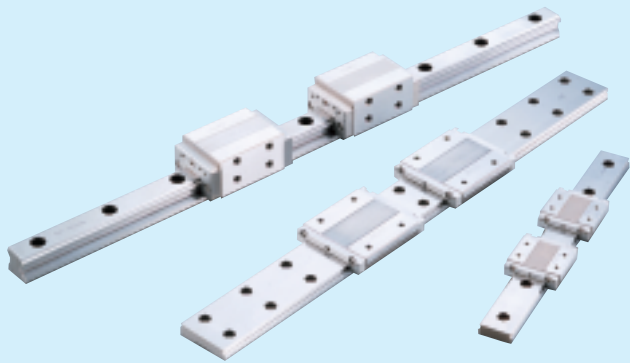

P.19~

# Special Environmental Specifications of Linear Motion Systems

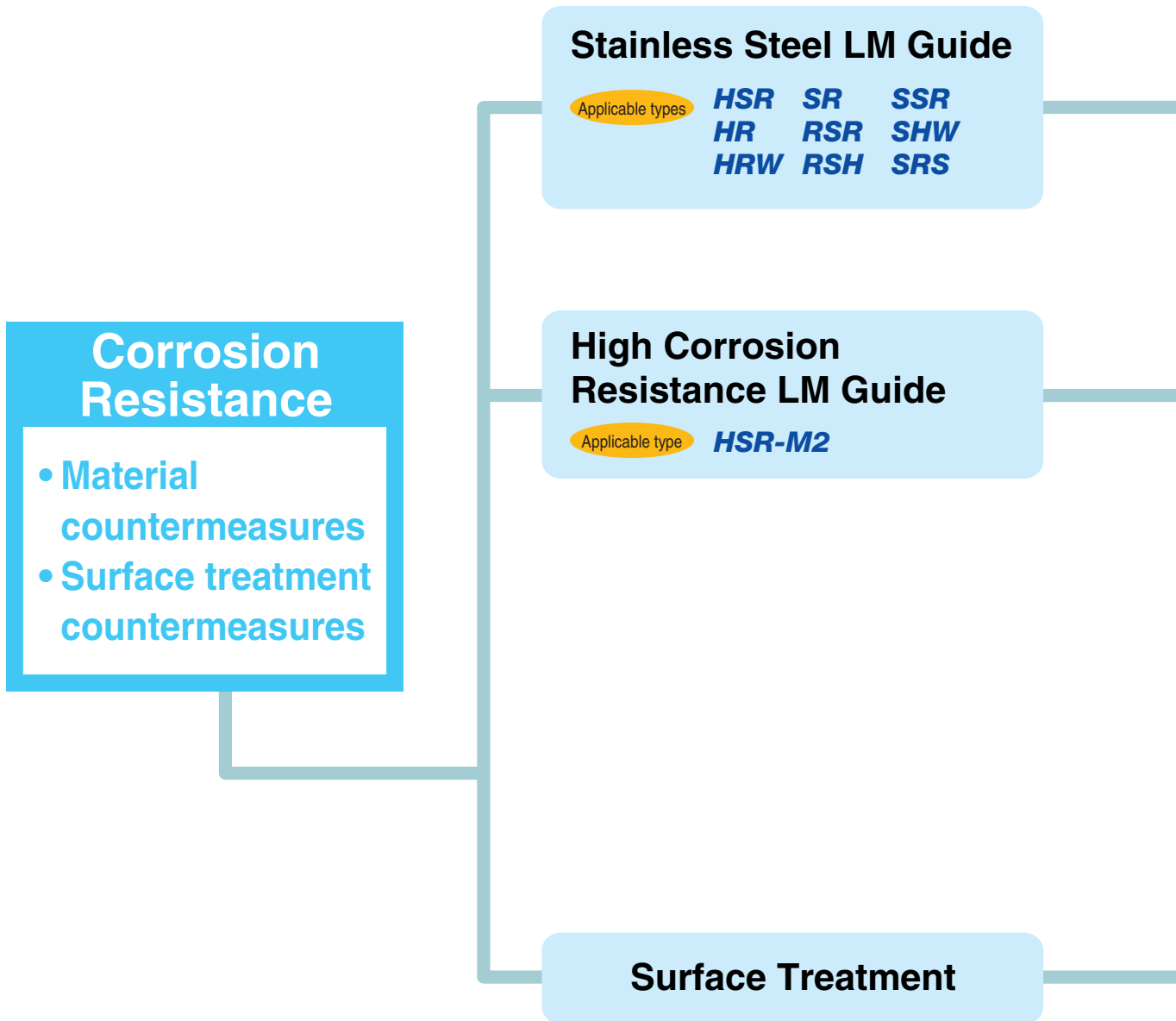

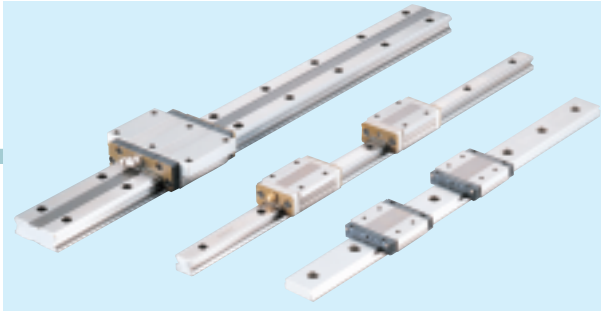

P.19~

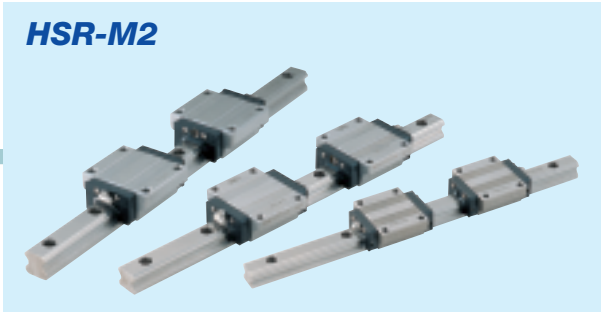

**HSR-M2**

P.19~

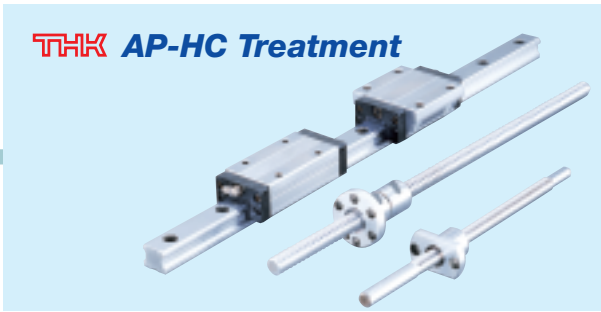

**THK AP-HC Treatment**

P.21~



**THK AP-C Treatment**

P.22~



**THK AP-CF Treatment**

P.22~

# Special Environmental Specifications of Linear Motion Systems

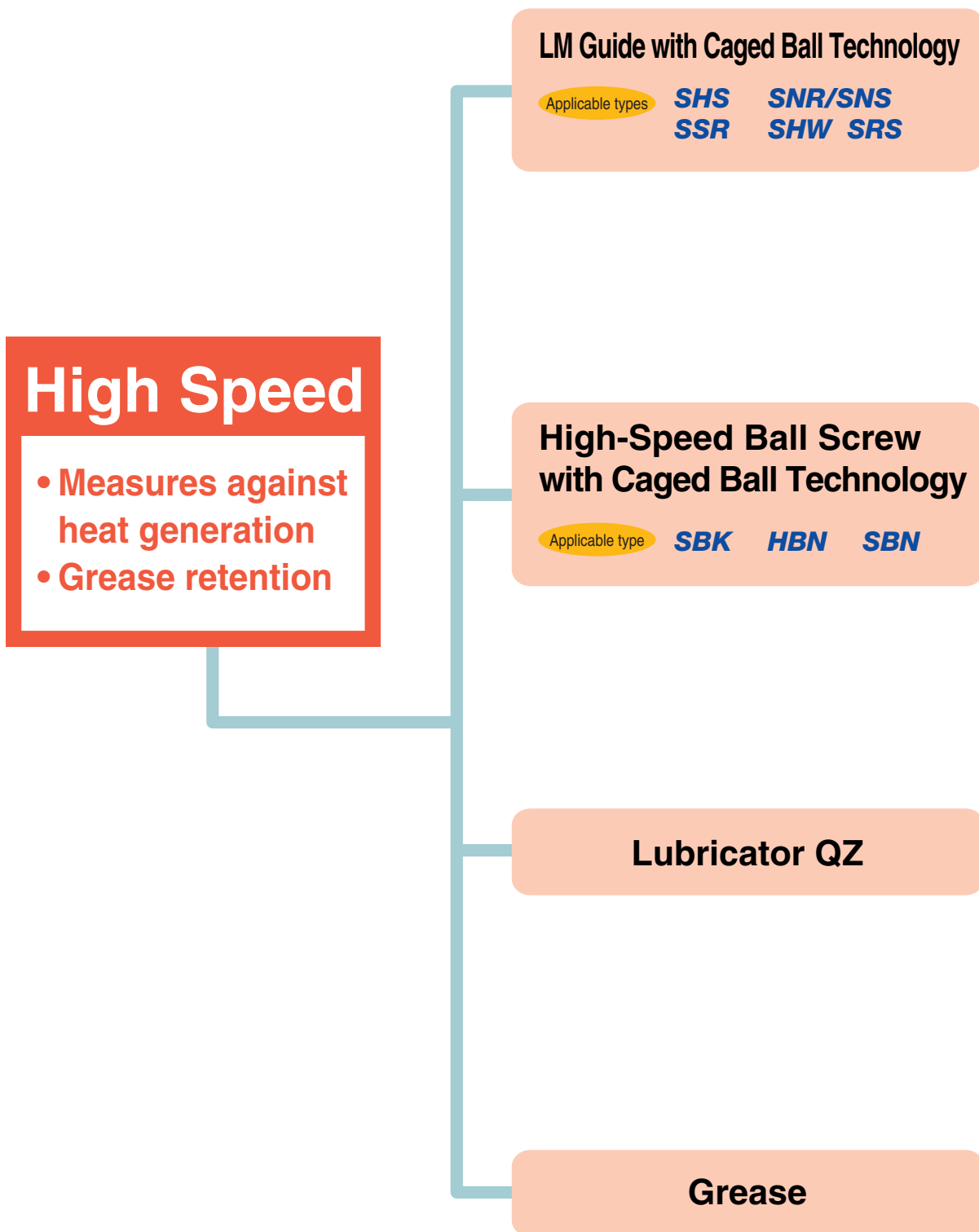

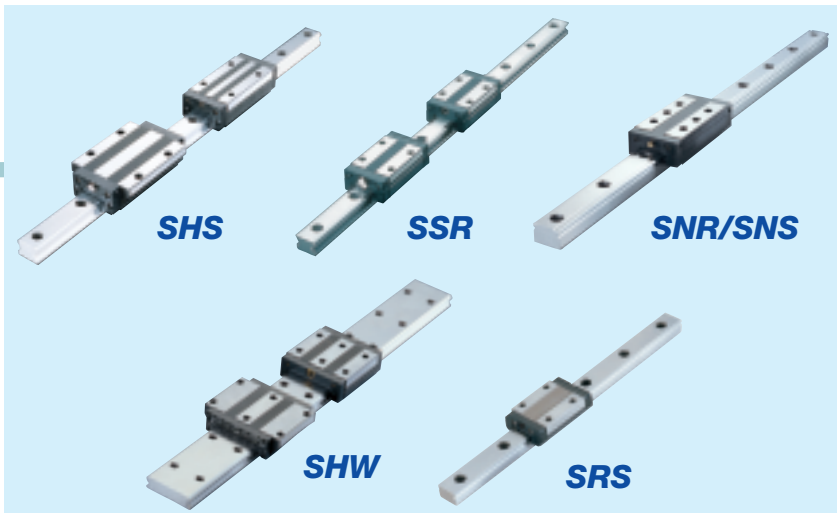

P.15~



P.17~



P.18~



P.18~



P.25~

# Special Environmental Specifications of Linear Motion Systems

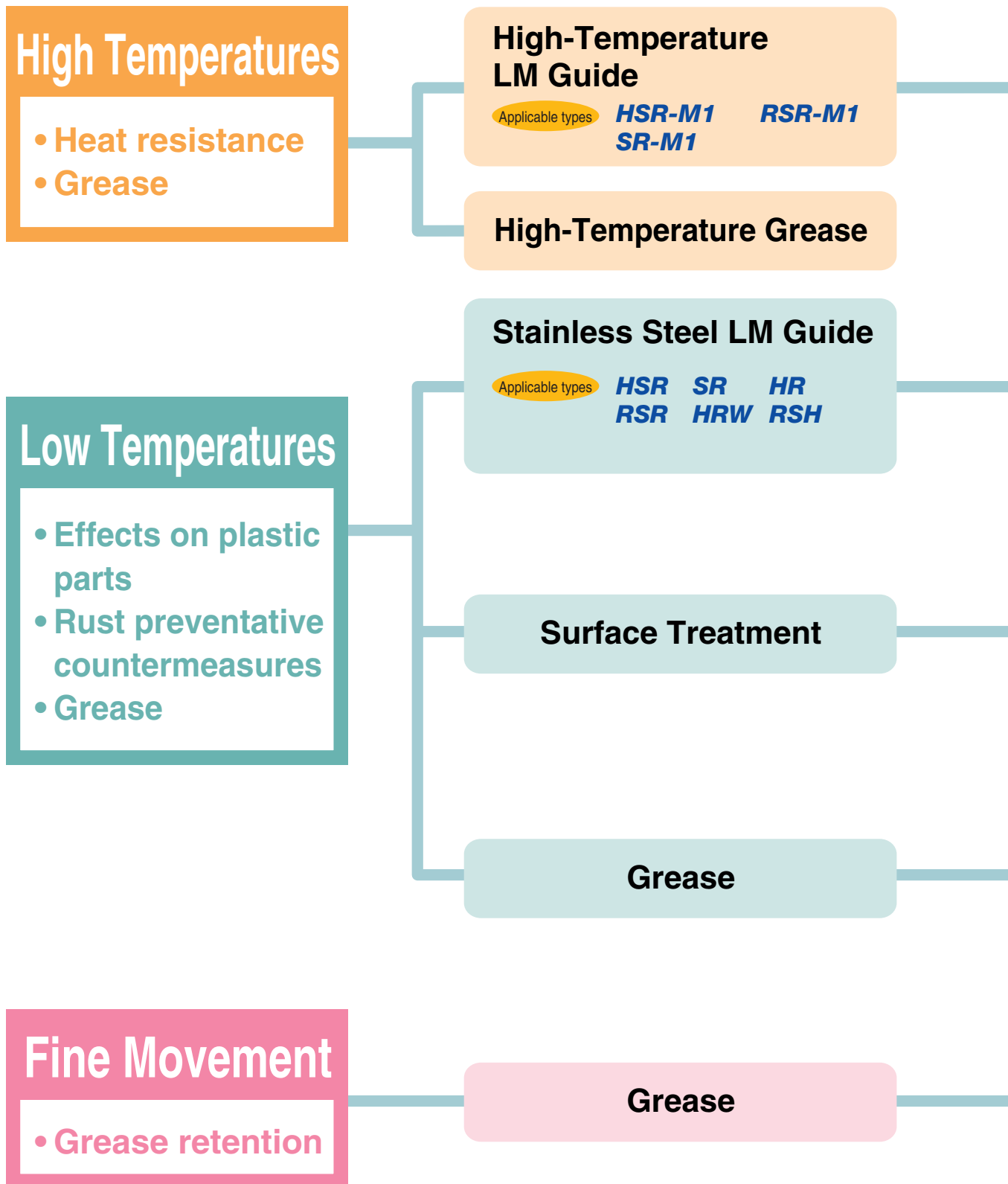

High  
Temperatures

Low  
Temperatures

Fine  
Movement

**HSR-M1**  
**SR-M1**  
**RSR-M1**

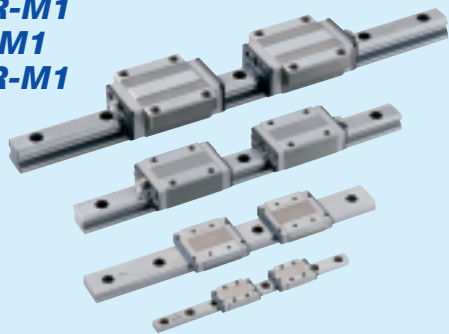

P.20~

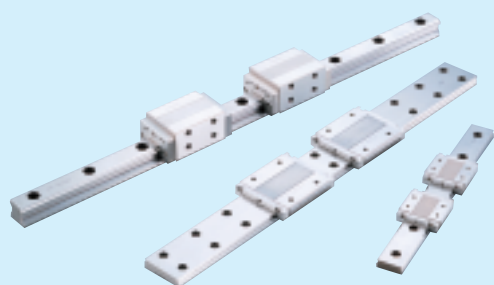

P.19~

**THK AP-CF Treatment**



P.22~

**THK AFC Grease**



P.26~

**THK AFC Grease**



P.26~

# LM Guide with Caged Ball Technology

Clean Rooms

High Speed

The LM Guide with Caged Ball is able to demonstrate outstanding low dust generation performance due to the low level of production of metal wear fragments as a result of the ball cage eliminating friction between the balls.

## Friction Between Balls

Conventional type (without ball cage)

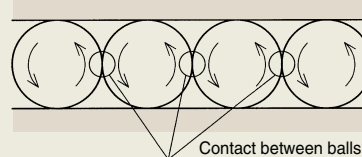
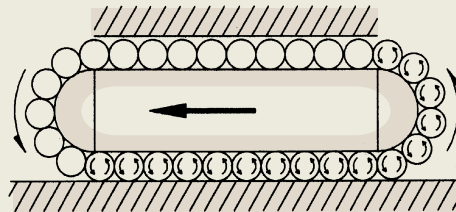

New type (with ball cage)

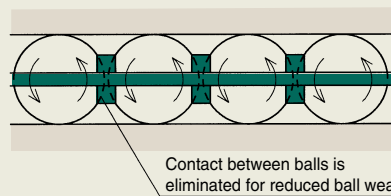
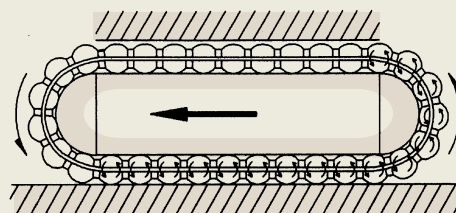

Contact structure between balls and ball cage

Ball cage



## Low Dust Generation Data

Particle size (µm)	0.3 – 0.5	2.0 – 5.0
	0.5 – 1.0	5.0 –
	1.0 – 2.0	

Conventional products (without ball cage)

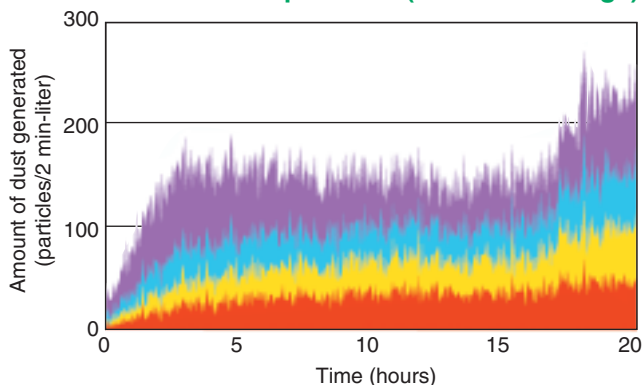

SSR20 (with ball cage)

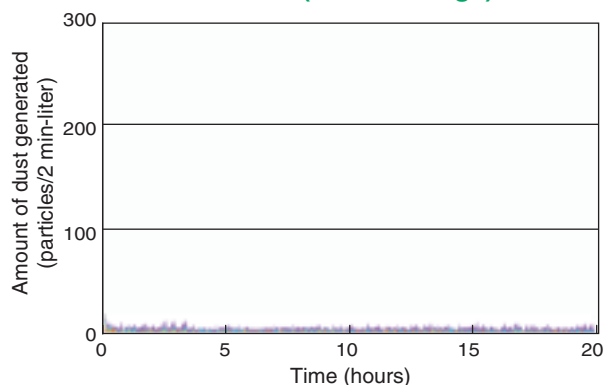

The use of ball cages reduces the generation of heat caused by friction between the balls, thereby improving grease retention capabilities and resulting in outstanding high-speed performance.

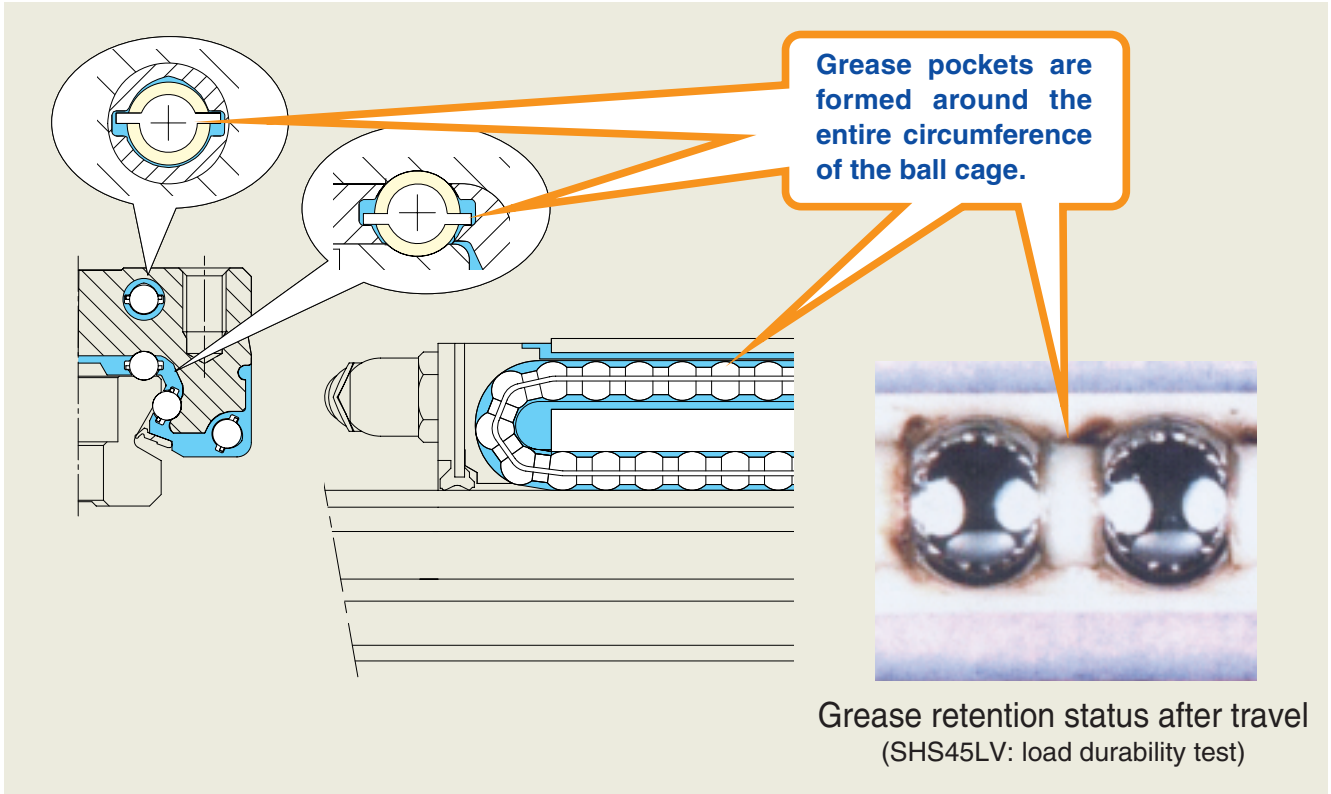

### High-Speed Durability Test Results

Sample : SHS65LVSS  
 Speed : 200 m/min  
 Stroke : 2,500 mm  
 Lubrication : Initial sealing of grease only  
 Acting load : 34.5 kN  
 Acceleration : 1.5 G

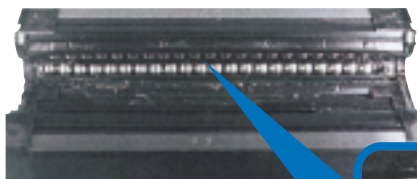
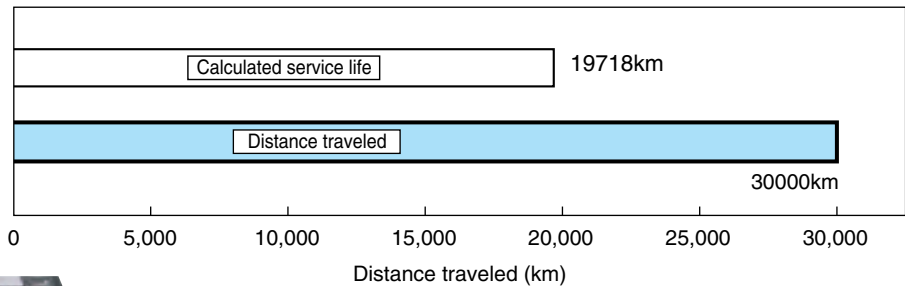

**Grease remains on the balls and there are no abnormalities observed in the balls or grease.**

Detailed illustration of ball cage

# High-Speed Ball Screw with Caged Ball Technology

High Speed

With High-Speed Ball Screw with Ball Cage model SBK, balls are evenly spaced by a ball cage to eliminate collision and friction between the balls and ensure a high level of grease retention. As a result, low noise, low torque fluctuation and long-term maintenance-free operation are achieved.

## Stress-free, ideal circulation structure

Balls circulate toward the tangential direction

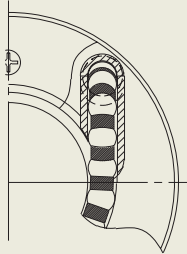

Balls circulate toward the lead-angle direction

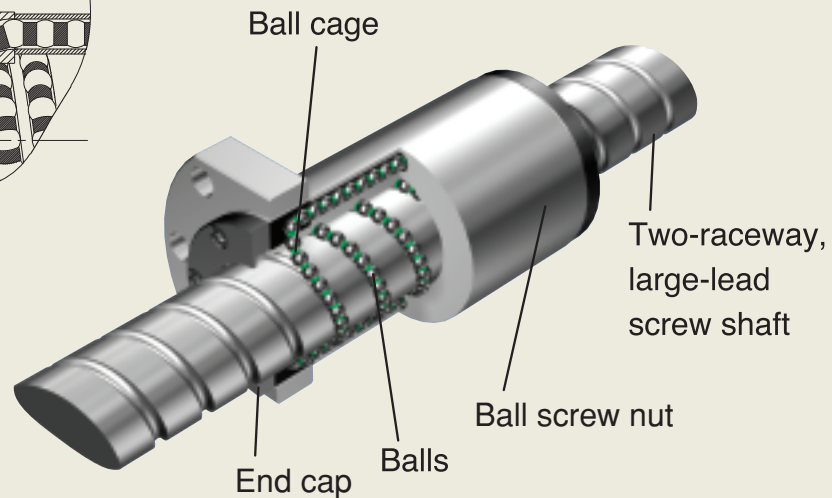
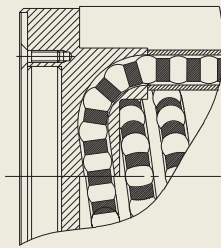

Structural Drawing of Model SBK

In addition, this model has an ideal circulation structure where balls are picked up in the tangential direction, thus to achieve a DN value\* of 160,000 (\* DN value = ball center diameter × rotation speed per minute) in high-speed operation.

### High-Speed Durability Test

#### Conditions

Sample	SBK4030-7.6
Speed	3800 (min <sup>-1</sup> ) (DN value: 160,000)
Stroke	700 mm
Lubricant	Multemp HRL grease
Amount applied	12 cm <sup>3</sup> (applied every 500 km)
Load	2.28 kN (0.038Ca)
Acceleration	1 G

#### Results

No abnormalities after 10,000 km of travel

### Load Durability Test

#### Conditions

Sample	SBK5530-7.6
Speed	1500 (min <sup>-1</sup> ) (DN value: 160,000)
Stroke	300 mm
Lubricant	Multemp HRL grease
Amount applied	16 cm <sup>3</sup> (applied every 500 km)
Load	22.5 kN (0.38Ca)
Acceleration	0.5 G

#### Results

Traveled 3.3 times the estimated service life

# Lubricator QZ



The LM Guide and Ball Screw lose a small amount of grease during the course of travel. The Lubricator QZ is a revolutionary new lubrication system that supplies an appropriate amount of lubricating oil at the appropriate locations, thereby enabling it to compensate for any oil lost over a long period of time. Installation of the Lubricator QZ on the LM Guide with Ball Cage or High-Speed Ball Screw with Ball Cage, demonstrating excellent grease retention capabilities, results in even further enhanced lubrication performance.

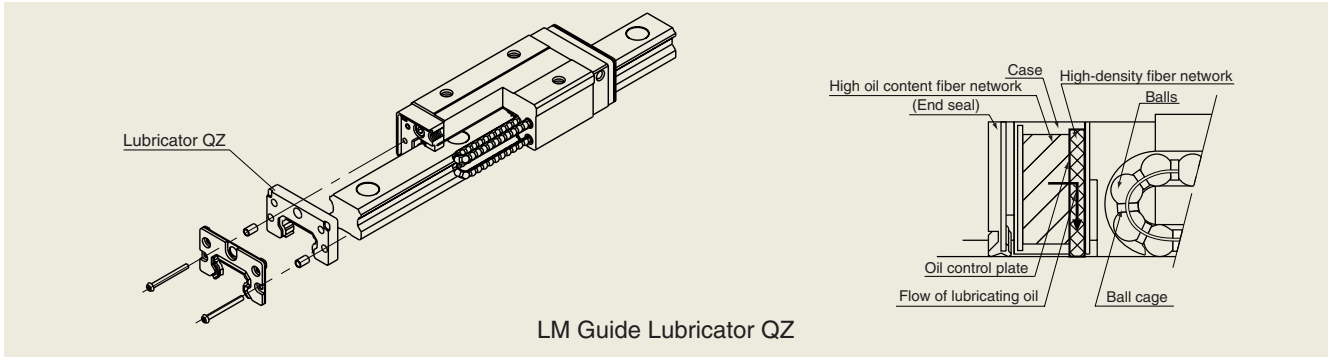

LM Guide Lubricator QZ

Since the Lubricator QZ supplies an optimal amount of lubricating oil at appropriate locations, lubricating oil can be used without waste.

### Comparison of Amount of Lubricating Oil Used After Travelling 5,000 km

Lubricator QZ oil content:  
 $0.166 \text{ cm}^3/\text{sheet} \times 2 \text{ sheets}$   
 $= 0.332 \text{ cm}^3$



Forced lubrication:  
 $0.03 \text{ cm}^3/6 \text{ min} \times 16667 \text{ min}$   
 $= 83.3 \text{ cm}^3$

Amount of lubricating oil used is 1/250 that of forced lubrication.

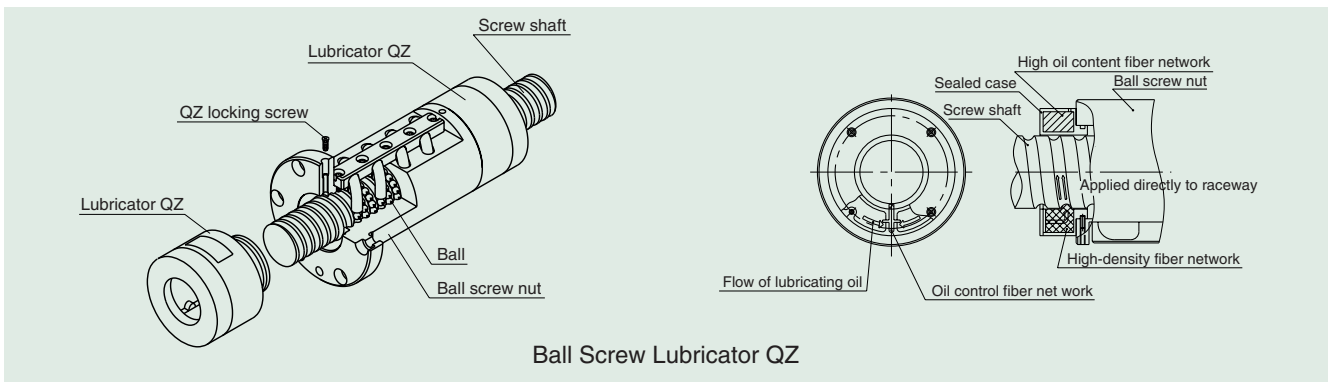
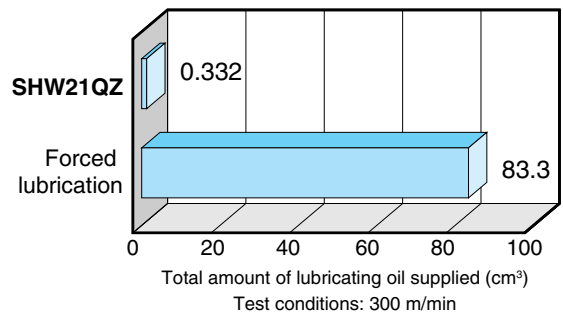

Ball Screw Lubricator QZ

### Significant Extension of Maintenance Intervals

Since lubricating oil continues to be supplied for a long time, maintenance intervals can be extended considerably.

Rotational speed	2500m/min <sup>-1</sup>
Max. speed	25m/min <sup>-1</sup>
Stroke	500 mm
Load	Internal preload only

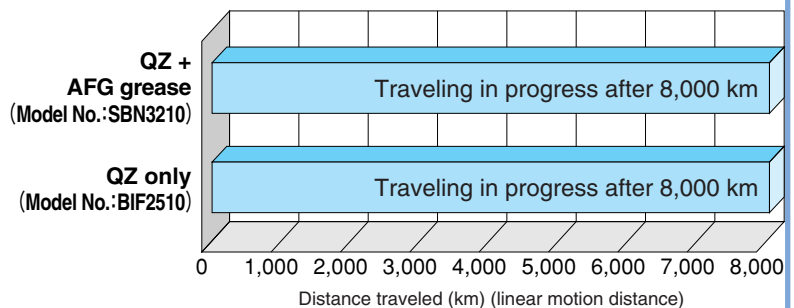

# Stainless Steel LM Guide

Clean Rooms

Vacuum

Corrosion Resistance

Low Temperatures

Stainless Steel LM Guide delivers outstanding corrosion resistance as a result of using martensite stainless steel. In addition, heat treatment to a level of HRC58 or higher results in a long service life, enabling it to withstand high loads.

Although plastic end plates are used in ordinary environments, when used in a vacuum environment, SUS304 (austenite stainless steel) is used for the end plates to reduce the level of released gases. SUS304 materials are characterized by low oxidation and low levels of released gases.

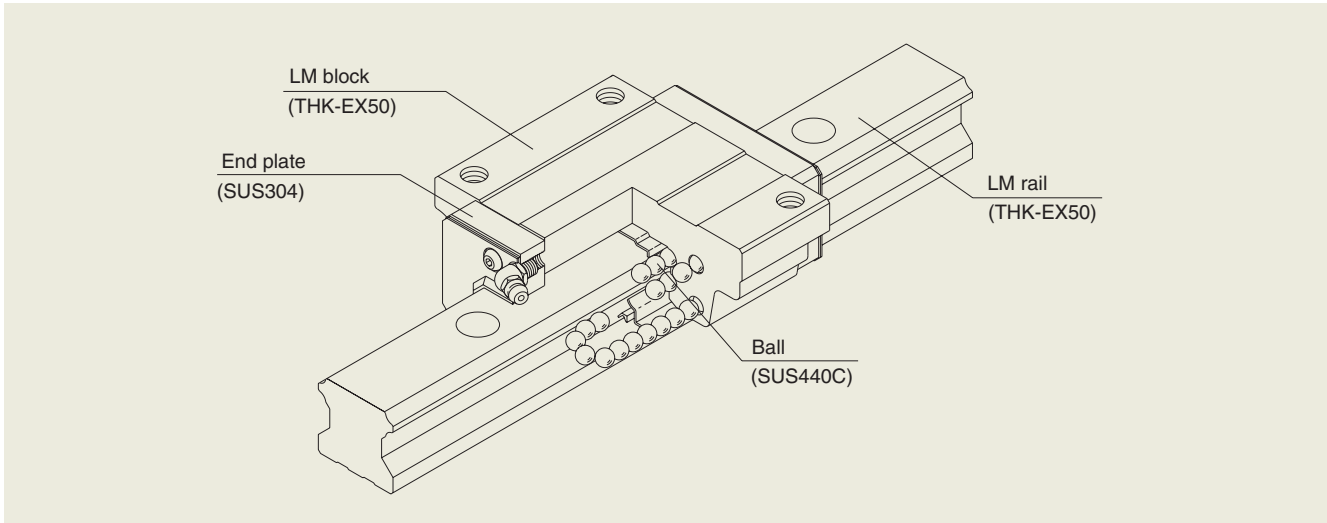

# High Corrosion Resistance LM Guide

Clean Rooms

Vacuum

Corrosion Resistance

Austenite stainless steel SUS304, offering excellent corrosion resistance, is used for the LM rail, while SUS431, offering the highest level of corrosion resistance among martensite stainless steel materials, is used for the LM block and balls. The result is a significant improvement in corrosion resistance over conventional stainless steel

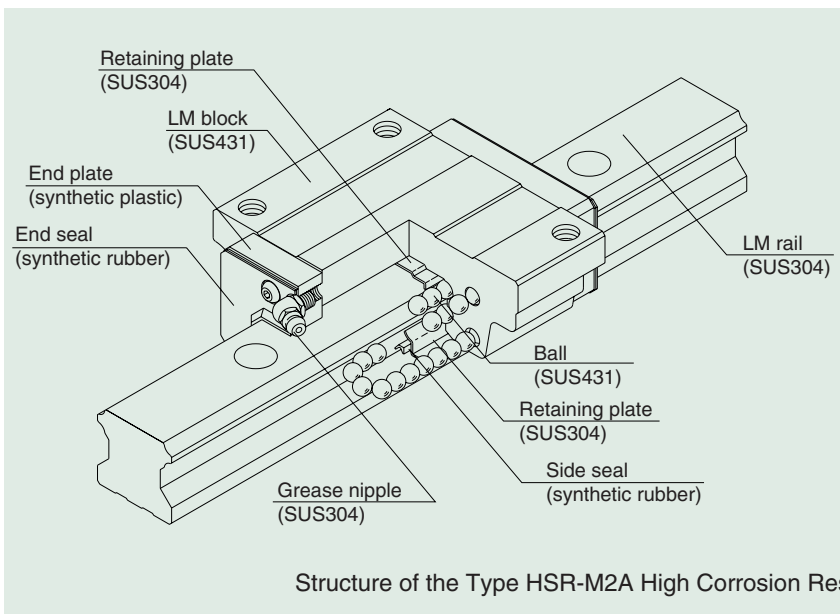

Structure of the Type HSR-M2A High Corrosion Resistance LM Guide

# High-Temperature LM Guide

Vacuum

High Temperatures

The LM block and LM rail are made of **THK**-EX50 martensite stainless steel additionally treated for dimensional stability to minimize the effects of heat on dimensional changes. SUS304 austenite stainless steel is used for the end plates for enhanced heat resistance.

Specific heat capacity	: 0.481J/(g·K)
Coefficient of thermal conductivity	: 20.67W/(m·K)
Mean coefficient of linear expansion	: 11.8×10 <sup>-6</sup> /°C

Structure and Materials of High-Temperature LM Guide (Type HSR)

## Dimensional Stability Data

Dimension stabilization treatment makes it possible to reduce dimensional changes following heating and cooling to extremely low levels.

- Total length and curvature data indicate the amount of change when from normal temperature to 150°C for 100 hours followed by cooling to normal temperature.
- HSR25 + 580L high-temperature, standard and stainless steel products were used for the samples.

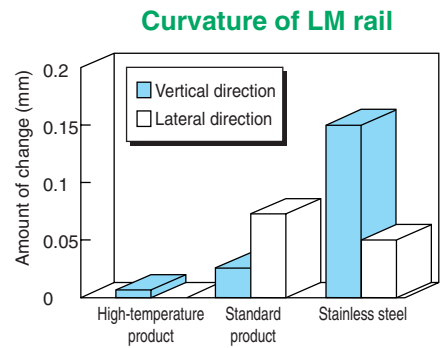
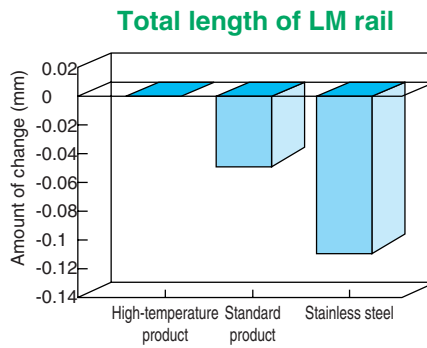

## Grease-Induced Rolling Resistance Data

High-temperature grease is used that minimizes changes and fluctuations (catching) in rolling resistance caused by the grease even when the temperature changes from normal temperature to high temperature.

HSR25M1R1C1 is used as the sample for the above data.

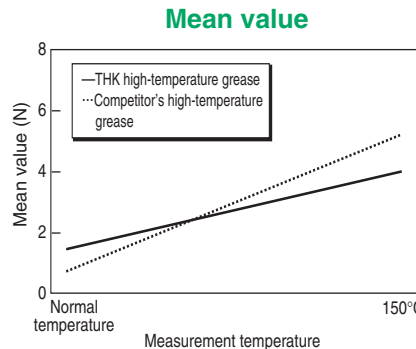

# Surface Treatment

Clean  
RoomsCorrosion  
ResistanceLow  
Temperatures

## THK AP-HC Treatment

THK AP-HC treatment is equivalent to hard chrome plating, and allows for corrosion resistance nearly equivalent to that of martensite stainless steel.

In addition, since surface treatment is performed that results in the formation of a film having a hardness of 700 HV or more, dust generation is reduced while offering outstanding wear resistance.

### Characteristics of THK AP-HC Treatment

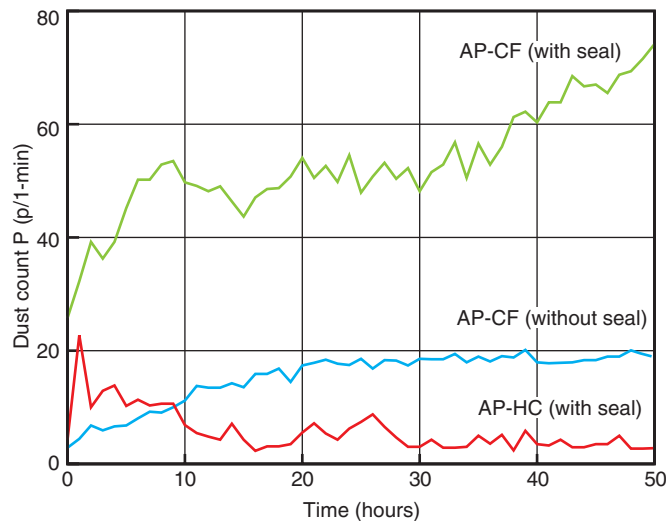

#### Test Conditions

LM guide model numbers :

SSR20WF + 280LF (AP-CF without seal)

SSR20UUF + 280LF (AP-CF with seal)

SSR20UUF + 280LF (AP-HC with seal)

Injected grease : THK AFE-CA Grease

Amount applied : 1 cc (1LM block)

Speed : 30 m/min (max)

Stroke : 200 mm

Measurement flow rate : 1 liter/min

Clean room volume : 1.7 liters (acrylic case)

Measuring instrument : Dust counter

Measured particle size : 0.3 μm and above

THK AP-HC treatment results in high surface hardness and offers excellent wear resistance. The large amount of wear occurring in the initial portion of the graph is considered to be attributed to initial wear of the end seals.

Note: THK AP-HC treatment (equivalent to hard chrome plating)

THK AP-CF treatment (equivalent to black chrome plating + fluororesin coating)

## ■ THK AP-C Treatment

THK AP-C treatment consists of black film treatment for the purpose of improving corrosion resistance. It is used in applications requiring rust prevention since it is priced lower than stainless steel LM guides.

















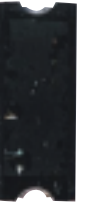

## ■ THK AP-CF Treatment

THK AP-CF treatment consists of compound surface treatment in which a special fluoro-resin is coated into a black film. Since this treatment results in complete coverage of metal surfaces, it offers a high degree of rust prevention and is suitable in cases requiring a high level of corrosion resistance. Moreover, since the fluoro-resin constitutes a chemically stable film, it also offers outstanding contamination resistance.

Surface treatment	Rust prevention capabilities	Wear resistance	Surface hardness	Sealing	Appearance
AP-HC	○	◎	◎	◎	Metallic gloss
AP-C	◎	△	△	△	Black gloss
AP-CF	◎	○	△	○	Black gloss

◎ (Superior)

Cycled saltwater spraying test  
 Sprayed solution : 1% NaCl solution  
 Cycle : Spraying for 6 hours followed by drying for 6 hours  
 Temperature conditions : During spraying : 35°C  
 During drying : 60°C

Test material Time	Austenite stainless steel	Martensite stainless steel	THK AP-HC	THK AP-C	THK AP-CF
Before testing					
After 6 hours					
After 24 hours					
After 96 hours					

# THK AFF Grease

Clean Rooms

**THK** AFF Grease is a high-grade synthetic oil that uses a lithium-based thickener and special additives to realize the perfect balance of stable rolling resistance, low dust generation and flaking resistance not possible with conventional vacuum grease and low dust generation grease.

The use of THK AFF Grease results in improved uniform velocity characteristics of the precision positioning units used in semiconductor and liquid crystal production systems as well as improved response during micro-step feeding. Moreover, due to its excellent flaking resistance to minute vibrations (fine movement wear performance), the intervals between lubrication times can be extended resulting in a reduction in maintenance costs.

## Typical Properties of AFF Grease

Test item	Representative value	Test method	
Worked penetration (25°C, 60W)	315	JIS K 2220 7	
Dropping point : °C	216	JIS K 2220 8	
Copper plate corrosion (100°C, 24h)	Accepted	JIS K 2220 9	
Evaporation amount : mass% (99°C, 22h)	0.43	JIS K 2220 10	
Oil separation rate : mass% (100°C, 24h)	2.6	JIS K 2220 11	
Stability of oxidation : kPa (99°C, 100h)	39	JIS K 2220 12	
No. of contaminants : pieces/cm <sup>3</sup> 25 μm or more	0	JIS K 2220 13	
75 μm or more	0		
125 μm or more	0		
Mixing stability (100,000 W)	329	JIS K 2220 15	
Low temperature torque : mN·m (-20°C)	Start	220	JIS K 2220 18
	Revolutions	40	
Apparent viscosity : Pa·s (-10°C, 10s <sup>-1</sup> )	340	JIS K 2220 19	
Timken load capacity : kg	5.44	JIS K 2220 20	
4-ball testing (burn-in load) : N	3089	ASTM D2596	
Fretting resistance : mg	3.8	ASTM D4170 compliant	
Bearing rust prevention : (52°C, 48h)	Accepted	ASTM D1743-73	
Service Temperature Range (°C)	- 40 to 120	—	

## Low Dust Generation Characteristics

### Test Conditions

Item	Description
Model used	SR20W + 280LP
Amount of grease injected	1 cm <sup>3</sup> /1 LM block (initial injection only)
Air supply volume	500 cm <sup>3</sup> /min
Measuring instrument	Particle counter
Measured particle size	0.3 μm and above
Speed	30 m/min
Stroke	200 mm

### Operating Time and Dust Generation

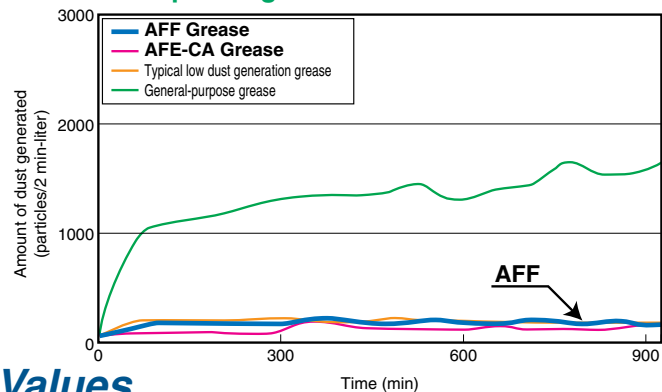

## Stable Rolling Resistance Values

### Test Conditions

Item	Description
Model used	HSR25A1C1 + 580LP
Amount of grease injected	3 cm <sup>3</sup> /1 LM block (initial injection only)
Speed	10 mm/s

(23°C)

### Test Conditions

Item	Description
Model used	HSR35RC0 + 440LP
Amount of grease injected	4 cm <sup>3</sup> /1 LM block (initial injection only)
Speed	1 mm/s
Stroke	3 mm

### Grease Viscous Resistance Values

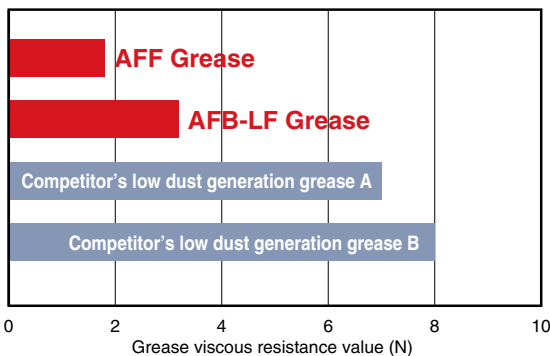

### Low-Speed Rolling Resistance Values

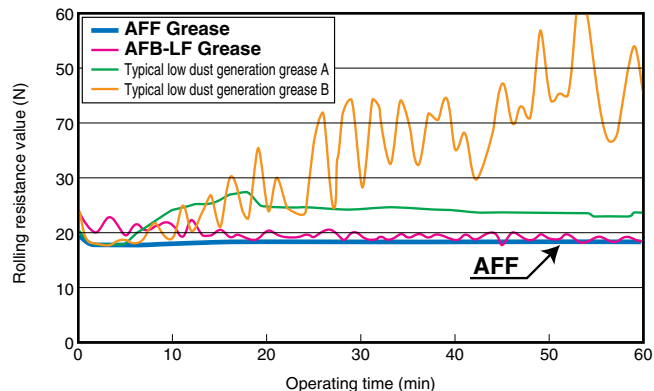

# THK AFE-CA Grease

Clean Rooms

**THK** AFE-CA Grease uses for its base oil a high-grade synthetic oil along with a urea-based thickener for outstanding low dust generation characteristics.

Since THK AFE-CA Grease is able to accommodate a wide temperature range from low temperatures to high temperatures, and generates lower levels of dust than vacuum grease and typical low dust generation grease conventionally used for low dust generation, it is optimal for the LM guide, ball screws and various other units of semiconductor and liquid display production systems. In addition, it also contributes to reduced maintenance costs by being able to significantly extend the service life of LM systems.

## Typical Properties of AFE-CA Grease

Test item	Representative value	Test method
Worked penetration (25°C, 60W)	260	JIS K 2220 7
Dropping point : °C	258	JIS K 2220 8
Copper plate corrosion (100°C, 24h)	Accepted	JIS K 2220 9
Evaporation amount : mass% (99°C, 22h)	0.1	JIS K 2220 10
Oil separation rate : mass% (100°C, 24h)	0.8	JIS K 2220 11
Stability of oxidation : kPa (99°C, 100h)	20	JIS K 2220 12
No. of contaminants : pieces/cm <sup>3</sup> 75 µm or more	0	JIS K 2220 13
125 µm or more	0	
Mixing stability (100,000 W)	311	JIS K 2220 15
Low temperature torque : mN·m (-20°C)	Start	JIS K 2220 18
	Revolutions	
Apparent viscosity : Pa·s (-10°C, 10s <sup>-1</sup> )	250	JIS K 2220 19
Bearing Corrosion prevention : (52°C, 48h)	Accepted	ASTM D1743-73
Service Temperature Limit (°C)	- 40 to 180	—

## Low Dust Generation Characteristics

### Test Conditions

Item	Description
Model used	Type KR4610
Ball screw rotating speed	1000min <sup>-1</sup>
Stroke	210mm
Amount of grease injected	Ball screw, LM guide: 2 cc
Measurement flow rate	1 ℓ/min
Measuring instrument	Dust counter
Particle size	0.5 µm

### LM System Operating Time and Dust Generation

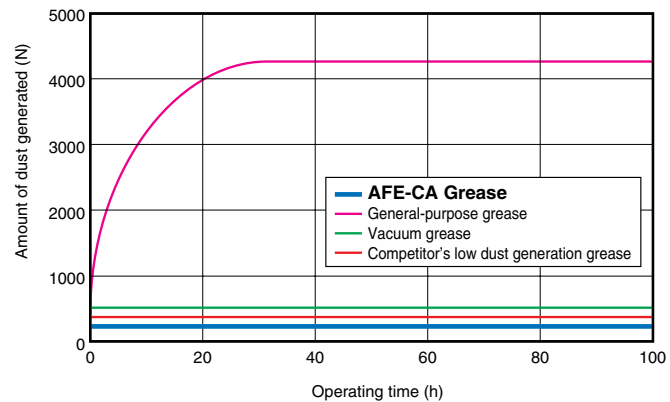

## Long Service Life Characteristics

### Surface Status of Balls After Traveling

Magnification: 200X

### Test Conditions

Item	Conditions
Model used	HSR25A
Speed	30m/min
Loaded	4.9kN
Amount of grease injected	1 cc/raceway (initial injection only)

Name	Distance traveled	
	290km	440km
<b>THK</b> AFE-CA Grease	Hardly any color change or damage	Hardly any color change or damage
Typical low dust generation grease		

# THK AFG Grease

High  
Speed

**THK** AFG Grease uses for its base oil a high-grade synthetic oil along with a urea-based thickener for outstanding low dust generation characteristics. It also reduces heat generation during high-speed use while offering excellent oxidation stability.

## Typical Properties of AFG Grease

Test item	Representative value	Test method
Worked penetration (25°C, 60W)	285	JIS K 2220 7
Dropping point : °C	261	JIS K 2220 8
Copper plate corrosion (100°C, 24h)	Accepted	JIS K 2220 9
Evaporation amount : mass% (99°C, 22h)	0.2	JIS K 2220 10
Oil separation rate : mass% (100°C, 24h)	0.5	JIS K 2220 11
Stability of oxidation : kPa (99°C, 100h)	80	JIS K 2220 12
Mixing stability (100,000 W)	329	JIS K 2220 15
Grease removal resistance during water rinse : mass% (38°C, 1h)	0.6	JIS K 2220 16
Low temperature torque : mN·m (-20°C)	Start	JIS K 2220 18
	Revolutions	
Bearing Corrosion prevention : (52°C, 48h)	Accepted	ASTM D1743-73
Service Temperature Limit (°C)	- 45 to 160	—

## Low Heat Generation Characteristics

### Test Conditions

Item	Description
Shaft diameter/lead	32/10mm
Speed	67 - 500mm/s
Shaft rotating speed	400 - 3000min <sup>-1</sup>
Stroke	400mm
Amount of grease injected	12cm <sup>3</sup>
Temperature measurement location	Nut exterior

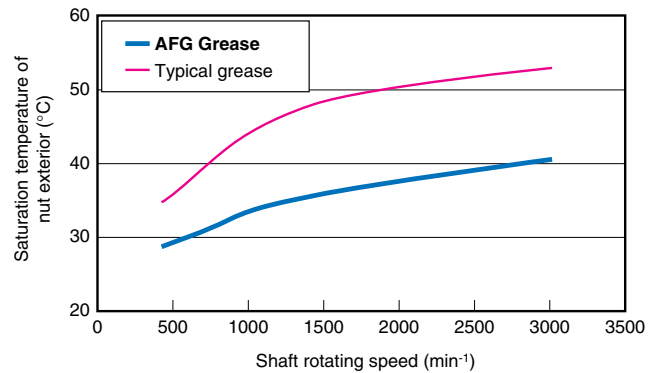

## Ball Screw High-Speed Durability Test

Combining with a ball screw with ball cage enabled use at ultra-high speeds at a DN value of 130,000.

### Test Conditions

Item	Description
Shaft diameter/lead	32/10mm
Max. rotating speed	3900 min <sup>-1</sup> (DN value: 130,000)
Stroke	400 mm
Acceleration	9.8 m/s <sup>2</sup>

### [Lubrication Conditions]

Lubricant : **THK** AFG Grease  
 Injection volume : 12 cm<sup>3</sup>  
 (initial injection only)

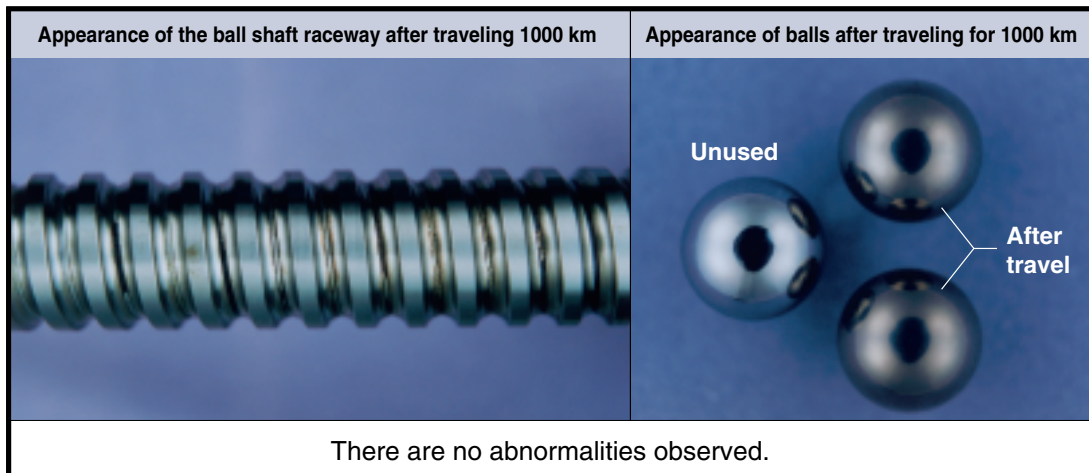

# THK AFC Grease

Fine  
Movement

**THK** AFC Grease uses a high-grade synthetic oil for its base oil along with a urea-based thickener and special additives to realize extremely outstanding flaking and corrosion resistance.

Since AFC Grease also offers excellent oxidation stability, the intervals between lubrication times can be extended resulting in a reduction in maintenance costs as compared with typical metallic soap-based grease.

## Typical Properties of AFC Grease

Test item	Representative value	Test method
Worked penetration (25°C, 60W)	288	JIS K 2220 7
Dropping point : °C	269	JIS K 2220 8
Copper plate corrosion (100°C, 24h)	Accepted	JIS K 2220 9
Evaporation amount : mass% (177°C, 22h)	7.9	JIS K 2220 10
Oil separation rate : mass% (177°C, 24h)	2	JIS K 2220 11
Stability of oxidation : kPa (99°C, 100h)	50	JIS K 2220 12
No. of contaminants : pieces/cm <sup>3</sup> 25 to 75 μm	370	JIS K 2220 13
	75μm or more	
Mixing stability (100,000 W)	341	JIS K 2220 15
Grease removal resistance during water rinse : mass% (38°C, 1h)	0.6	JIS K 2220 16
Low temperature torque : mN·m (-54°C)	Start	JIS K 2220 18
	Revolutions	
Bearing Corrosion prevention : (52°C, 48h)	Accepted	ASTM D1743-73
Vibration test (200h)	Accepted	—
Service Temperature Limit (°C)	-54 to 177	—

## Flaking and Corrosion Resistance Test Data

### Test Conditions

Item	Description
Stroke	3 mm
Strokes/min	200 min <sup>-1</sup>
Total strokes	2.88 × 10 <sup>5</sup> (24 hours)
Bearing pressure	1118MPa
Amount of grease injected	12 g/unit (supplied every 8 hours)

### AFC Grease

Before travel

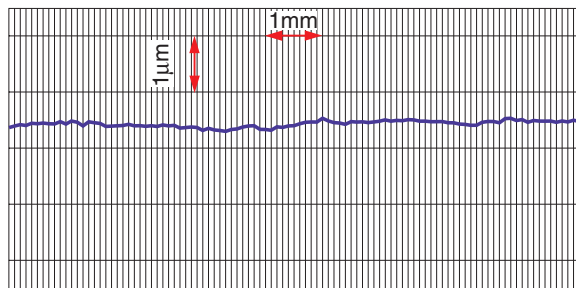

After travel

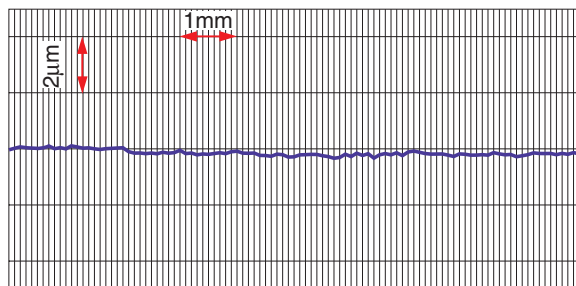

### General-purpose grease

Before travel

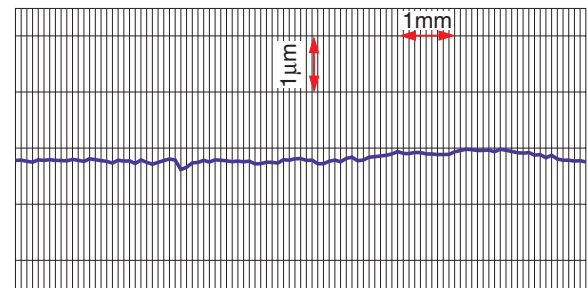

After travel

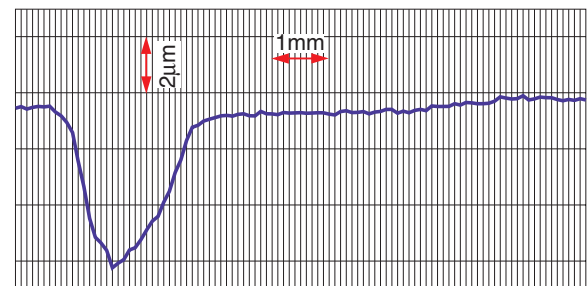

● “LM GUIDE” and “” are registered trademarks of THK CO., LTD.

- The photo may differ slightly in appearance from the actual product.
  - The appearance and specifications of the product are subject to change without notice. Contact THK before placing an order.
  - Although great care has been taken in the production of this catalog, THK will not take any responsibility for damage resulting from typographical errors or omissions.
  - For the export of our products or technologies and for the sale for exports, THK in principle complies with the foreign exchange law and the Foreign Exchange and Foreign Trade Control Law as well as other relevant laws.
- For export of THK products as single items, contact THK in advance.

All rights reserved

# THK CO., LTD.

HEAD OFFICE 3-11-6, NISHI-GOTANDA, SHINAGAWA-KU, TOKYO 141-8503 JAPAN  
INTERNATIONAL SALES DEPARTMENT PHONE:+81-3-5434-0351 FAX:+81-3-5434-0353  
Global site : <http://www.thk.com/>

## NORTH AMERICA

THK America, Inc.

### ● HEADQUARTERS

Phone:+1-847-310-1111 Fax:+1-847-310-1271

### ● CHICAGO OFFICE

Phone:+1-847-310-1111 Fax:+1-847-310-1182

### ● NORTH EAST OFFICE

Phone:+1-845-369-4035 Fax:+1-845-369-4909

### ● ATLANTA OFFICE

Phone:+1-770-840-7990 Fax:+1-770-840-7897

### ● LOS ANGELES OFFICE

Phone:+1-949-955-3145 Fax:+1-949-955-3149

### ● SAN FRANCISCO OFFICE

Phone:+1-925-455-8948 Fax:+1-925-455-8965

### ● DETROIT OFFICE

Phone:+1-248-858-9330 Fax:+1-248-858-9455

### ● TORONTO OFFICE

Phone:+1-905-820-7800 Fax:+1-905-820-7811

## SOUTH AMERICA

THK Brasil LTDA

Phone:+55-11-3767-0100 Fax:+55-11-3767-0101

## EUROPE

THK GmbH

### ● EUROPEAN HEADQUARTERS

Phone:+49-2102-7425-555 Fax:+49-2102-7425-556

### ● DÜSSELDORF OFFICE

Phone:+49-2102-7425-0 Fax:+49-2102-7425-299

### ● FRANKFURT OFFICE

Phone:+49-2102-7425-650 Fax:+49-2102-7425-699

### ● STUTTGART OFFICE

Phone:+49-7150-9199-0 Fax:+49-7150-9199-888

### ● MÜNCHEN OFFICE

Phone:+49-8937-0616-0 Fax:+49-8937-0616-26

### ● U.K. OFFICE

Phone:+44-1908-30-3050 Fax:+44-1908-30-3070

### ● ITALY MILANO OFFICE

Phone:+39-039-284-2079 Fax:+39-039-284-2527

### ● ITALY BOLOGNA OFFICE

Phone:+39-051-641-2211 Fax:+39-051-641-2230

### ● SWEDEN OFFICE

Phone:+46-8-445-7630 Fax:+46-8-445-7639

### ● AUSTRIA OFFICE

Phone:+43-7229-51400 Fax:+43-7229-51400-79

### ● SPAIN OFFICE

Phone:+34-93-652-5740 Fax:+34-93-652-5746

### ● TURKEY OFFICE

Phone:+90-216-362-4050 Fax:+90-216-569-7150

### ● PRAGUE OFFICE

Phone:+420-2-41025-100 Fax:+420-2-41025-199

### ● MOSCOW OFFICE

Phone:+7-495-649-80-47 Fax:+7-495-649-80-44

THK Europe B.V.

### ● EINDHOVEN OFFICE

Phone:+31-040-290-9500 Fax:+31-040-290-9599

THK France S.A.S.

Phone:+33-4-3749-1400 Fax:+33-4-3749-1401

## CHINA

THK (CHINA) CO.,LTD.

### ● HEADQUARTERS

Phone:+86-411-8733-7111 Fax:+86-411-8733-7000

### ● SHANGHAI OFFICE

Phone:+86-21-6219-3000 Fax:+86-21-6219-9890

### ● BEIJING OFFICE

Phone:+86-10-8441-7277 Fax:+86-10-6590-3557

### ● CHENGDU OFFICE

Phone:+86-28-8526-8025 Fax:+86-28-8525-6357

### ● GUANGZHOU OFFICE

Phone:+86-20-8523-8418 Fax:+86-20-3801-0456

THK (SHANGHAI) CO.,LTD.

Phone:+86-21-6275-5280 Fax:+86-21-6219-9890

## TAIWAN

THK TAIWAN CO.,LTD.

### ● TAIPEI HEAD OFFICE

Phone:+886-2-2888-3818 Fax:+886-2-2888-3819

### ● TAICHUNG OFFICE

Phone:+886-4-2359-1505 Fax:+886-4-2359-1506

### ● TAINAN OFFICE

Phone:+886-6-289-7668 Fax:+886-6-289-7669

## KOREA

SEOUL REPRESENTATIVE OFFICE

Phone:+82-2-3468-4351 Fax:+82-2-3468-4353

## SINGAPORE

THK LM SYSTEM Pte. Ltd.

Phone:+65-6884-5500 Fax:+65-6884-5550

## INDIA

BANGALORE REPRESENTATIVE OFFICE

Phone:+91-80-2330-1524 Fax:+91-80-2314-8226

